

リエントリーカプセル

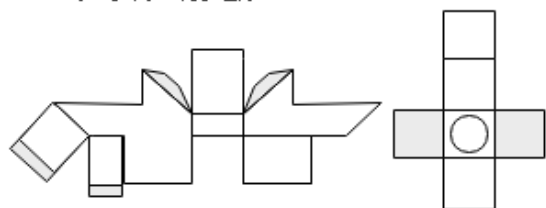

リエントリーカプセル基部

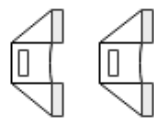
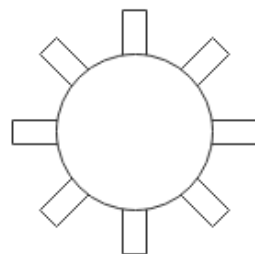
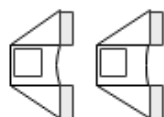

往路モジュールシリンダ (Return module cylinder)

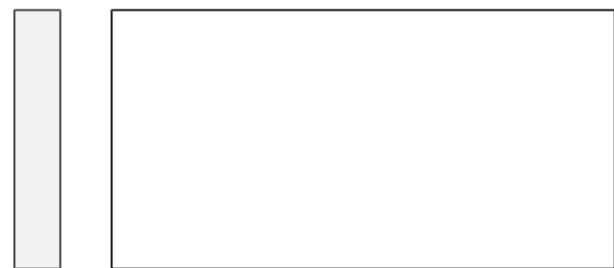

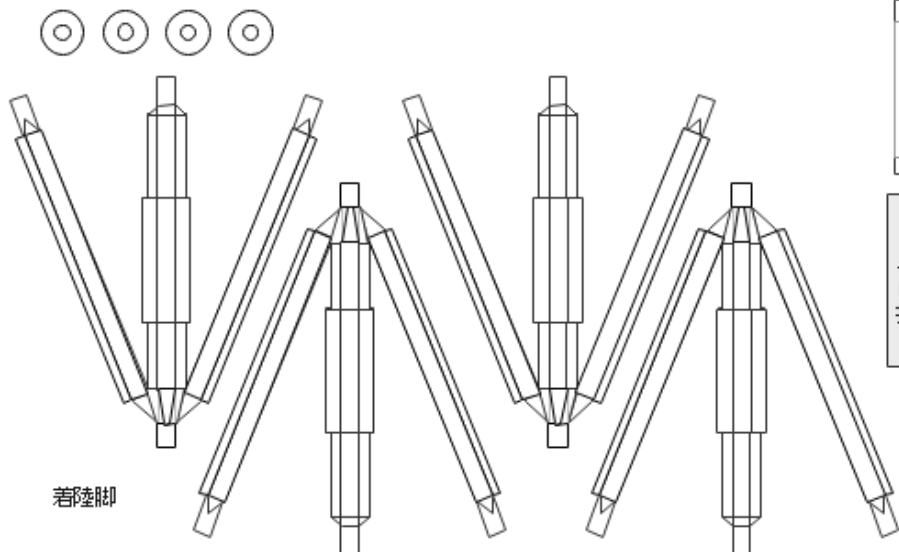
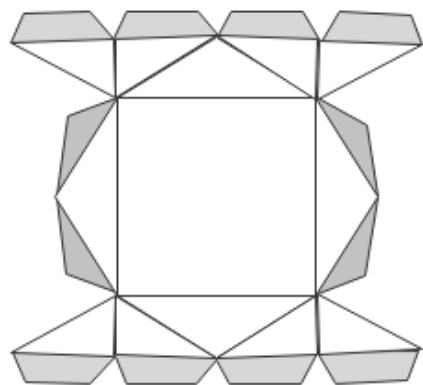

着陸脚



セントラルシリンダ接続用

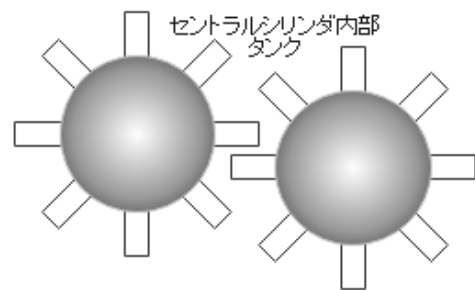

セントラルシリンダ内部タンク

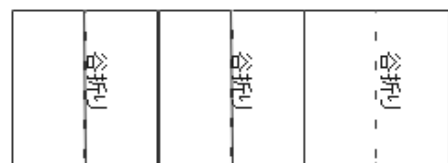

セントラルシリンダ 芯

ミッションパネル上

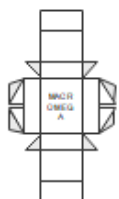

MGA A

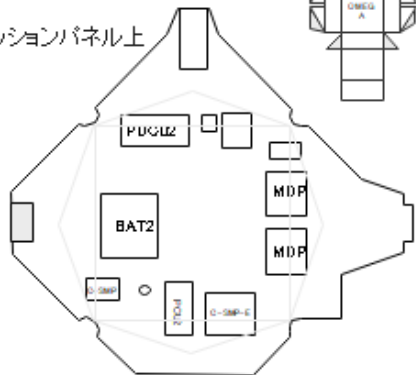

ミッションパネル下

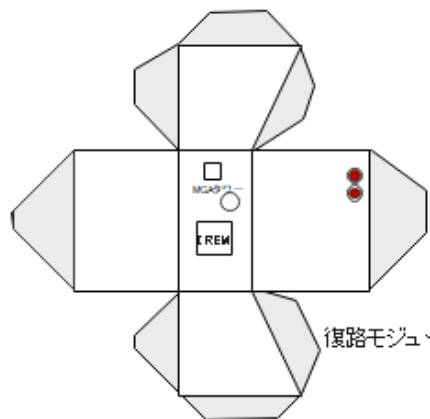
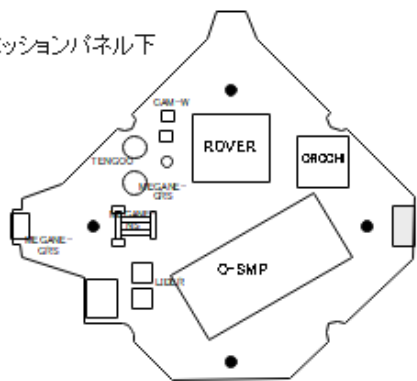

復路モジュール突起

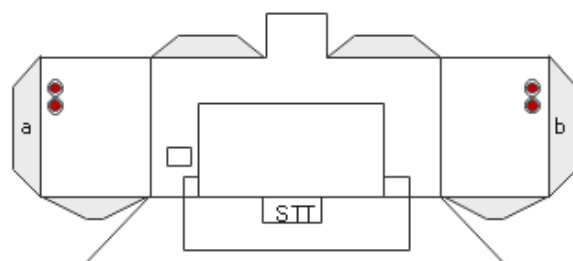

STT

穴



MGA

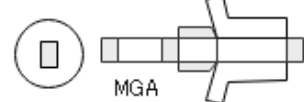

MGA

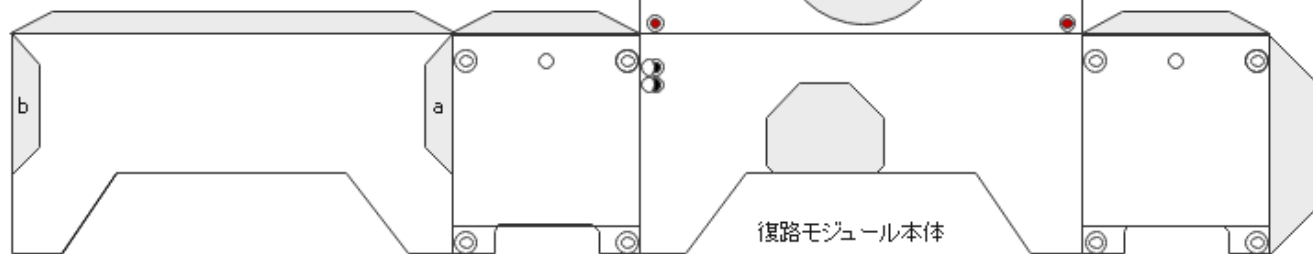

復路モジュール本体



スラスタ



